

UNIFICATION OF INTERACTIONS IN THE THEORY OF PHYSICAL VACUUM

Shipov G.I.

1 Introduction

In field theory all physical theories can be divided into two classes - fundamental and phenomenological.

Fundamental theories are based on fundamental physical principles and solutions of their equations result in fundamental potentials. In modern physics there are only two such field theories, one of which results in Newton potential, and another - to Coulomb potential. Indeed, theory of Newton gravitation and its relativistic generalization, Einstein theory, describe static field of gravitational mass M through Newton potential¹

$$\varphi_H = -\frac{MG}{r}. \quad (1)$$

On the other hand, solution of Maxwell - Lorentz equations of classical electrodynamics and also their quantum generalization leads to description of static field of charge Ze through Coulomb potential²

$$\varphi_K = \frac{Ze}{r}. \quad (2)$$

The potentials (1) and (2) are generated by point distribution of matter, that undoubtedly is an idealization and limits the area of their application.

The remarkable property of the fundamental theories is the precise coincidence of outcomes of theoretical calculations with the experimental data in that area, where this theory is true. It is this property, which makes fundamental theory an irreplaceable tool in cognition of the ambient world and allows effectively using our knowledge for life improving of man.

All other experimentally discovered interactions are constructive (or phenomenological) ones now. To the constructive field theories in microcosm one can attribute the theory of strong and weak interactions, and also the theory of electromagnetic formfactors. A characteristic property of constructive theories is presence in them fitting parameters. For example, Rarita W. and Schwinger J. have chosen (not as the outcome of solution of theory equations, but simply " have entered into the theory by hands", basing on experimental facts) the following phenomenological potential describing tensorial character of nuclear forces [1]

$$V = \begin{cases} V_0 \{(1 - g/2) + g(\boldsymbol{\sigma}_1 \boldsymbol{\sigma}_2)/2 + \gamma S_{12}\} & \text{when } r < r_0 \\ 0 & \text{when } r > r_0 \end{cases},$$

¹In Einstein theory of gravitation Newton potential is expressed through gravitational radius r_g according to the ratio $\varphi_H = -c^2 r_g / 2r$.

²In quantum electrodynamics there are minor changes of Coulomb potential created by electron-positron fluctuations of vacuum.

$$S_{12} = 3(\boldsymbol{\sigma}_1 \mathbf{n})(\boldsymbol{\sigma}_2 \mathbf{n}) - (\boldsymbol{\sigma}_1 \boldsymbol{\sigma}_2).$$

Here \mathbf{n} - unit vector, $\boldsymbol{\sigma}$ - Pauli matrixes and fitting parameters g and γ are taken from experimental data.

The use of fitting parameters in the theory results in limitation of its predicting properties. Besides that, when developing a constructive theory becomes invisible, since one have to include in it more and more separate experimental facts, that makes the theory empty. It is clear, that a descriptive theory has preliminary character and represents the first step in cognition of new phenomena. The main purpose of theoretical physics should be creation pithy, i.e. fundamental, theories, with in development of fundamental theory the deductive approach predominating in contrary to inductive one, used in construction of descriptive theory.

One of the reasons of stagnation in modern theory of elementary particles appears to be its descriptive character with all shortages, intrinsic to this kind of theory. Such fundamental particle as proton can participate in strong, weak, electromagnetic and gravitational interactions, that is why theory of proton should integrate all listed interactions. Even on the path of construction of descriptive theory nobody still managed the problem.

At one time A.Einstein has noticed, that when constructing of complex theory the deductive approach supposing a suggestion of some general physical principle should predominate, on basis of which the search of new fundamental physical equations is conducted. It was this path, that was chosen by the author for unification of interactions known to modern physics. As the outcome of the solution of problems, posed before theoretical physics by A.Einstein, it was possible to show, that the unification of known interactions represents only some part of A.Einstein's unified field theory program, which in turn constitutes one of parts of the physical vacuum theory [2].

Present paper shows, that equations of the theory of physical vacuum, based on universal principle of relativity [2], allow to get the solution, from which the superpotential integrating gravitational, electromagnetic, strong and weak interactions results. From the superpotential analysis one can see, that the nature of shape factors of elementary particles is connected to weak interactions, which in turn have torsion (i.e. spin-rotary) nature.

2 Realization of Einstein program of unified field theory

In the beginning of the century A. Einstein has formulated theoretical program of creation of unified field theory, which implies existence of some equations integrating all kinds of interactions [3]. Within framework of this program it was implied to solve two problems:

- a) as the minimum to find equations of geometrized electrodynamics, which then should be united with geometrized equations of gravitational field, Einstein's equations;
- b) as the maximum it is necessary to geometrize the matter fields, located in right part of Einstein equations (i.e. to geometrize equations of quantum field theory), so that ultimately to unite general relativity theory with quantum field theory.

Brief account of solution of these problems by the author is submitted below.

2.1 Solution of the geometrization problem of electrodynamics equations

The electrodynamics equations, both classical and quantum, are far from perfection, since they contain a number of unsolved difficulties. The ones include: the divergences problem, radiations of accelerated charge and limitation of special principle in the description of charges motion in strong electromagnetic fields ($E, H \geq 10^{16}$ un. *SGSE*) or at large energy of particles [2].

One manages to remove these difficulties, if to enter in the electrodynamics alongside with Lorentz reference systems the accelerated locally Lorentz systems connected to charges [4], with the electrodynamics equations appearing to be geometrized. The space of events of such electrodynamics appears to be Riemannian, and field equations and equation of motion of trial charge are similar to ones of Einstein gravitation theory.

$$R_{jm} - \frac{1}{2}g_{jm}R = \frac{8\pi e}{mc^4}T_{jm}, \quad (3)$$

$$\frac{d^2x^i}{ds^2} + \frac{e}{mc^2}E^i{}_{jk} \frac{dx^j}{ds} \frac{dx^k}{ds} = 0, \quad (4)$$

$$R^i{}_{jkm} = -\frac{2e}{mc^2}E^i{}_{j[m,k]} + \frac{2e^2}{m^2c^4}E^i{}_{s[k}E^s{}_{|j|m]}, \quad (5)$$

$$E^i{}_{jk} = -\frac{c^2}{2}g^{im}(a_{mj,k} + a_{mk,j} - a_{jk,m}), \quad (6)$$

$$i, j, k \dots = 0, 1, 2, 3,$$

where the strong electromagnetic fields $E^i{}_{jk} = E^i{}_{kj}$ are determined through the metric tensor of general relativistic electrodynamics

$$g_{ik} = \eta_{ik} + \frac{e}{m}a_{ik} \quad (7)$$

and generally have nontensor character of coordinates transformation

$$\frac{e}{mc^2}E^{k'j'i'} = \frac{\partial^2x^k}{\partial x^{i'}\partial x^{j'}} \frac{\partial x^{k'}}{\partial x^k} + \frac{\partial x^i}{\partial x^{i'}} \frac{\partial x^j}{\partial x^{j'}} \frac{\partial x^{k'}}{\partial x^k} \frac{e}{mc^2}E^k{}_{ji}, \quad (8)$$

i.e. by coordinates selection xi they can be (locally) vanished.

Energy-momentum tensor of charged matter is written as

$$T_{jm} = \rho_e c^2 u_j u_m, \quad u^i u_i = 1, \quad (9)$$

with density of charged matter ρ_e , submitted through Dirac δ -function

$$\rho_e = e\delta(\mathbf{r}). \quad (10)$$

The solution of field equations (3) for space of events of a physical situation, in which the interaction of trial charge e with mass m with the field of charge Ze having mass M happens, results in the metric

$$ds^2 = \left(1 - \frac{r_e}{r}\right) c^2 dt^2 - \left(1 - \frac{r_e}{r}\right)^{-1} dr^2 - r^2(d\theta^2 + \sin^2\theta d\varphi^2), \quad (11)$$

where

$$r_e = \frac{2Ze^2}{mc^2} \quad (12)$$

- electromagnetic radius. It is easy to see, that for interaction of electron - positron pair the electromagnetic radius (12) is equal to double classical radius of electron.

The analysis of field equations (3) has shown, that they have the following properties:

1) they transform into equations of Maxwell electrodynamics in the approximation of weak fields ($E, H \ll 10^{16}$ un. SGSE) and at not too large speeds³;

2) they allow to happen an accelerated nonradiating motion of charges in central forces field (the general relativity analog of Bohr principle), i.e. one of the main quantum principles was contained in equations (3) as the corollary ;

3) the solutions of vacuum equations ($R_{ik} = 0$) of general relativistic electrodynamics allowed to get not only Coulomb potential, but also new static potentials;

4) the energy of Coulomb electrostatic field of charge, described by the metric (11), has appeared to be a limited quantity;

5) the potentials have allowed to describe in fundamental manner the deviation from Coulomb scattering of α -particles on nuclei (nuclear interactions), discovered by E. Reserford, that results in natural unification of electromagnetic and nuclear interactions at the level of potentials [8],[9].

2.2 Solution of the problem of geometrization of matter fields

Field equations of general relativistic electrodynamics (3), as well as the field equations of Einstein gravitation theory, contain in the right part the energy-momentum tensor of matter, not having geometric nature. One manages to execute the geometrization of this tensor, if one enters the full description of accelerated reference system. The thing is that in general case accelerated system has 10 degrees of freedom: four translational, being described in translational coordinates x_0, x_1, x_2, x_3 , and six rotary, being submitted by three spatial angles $\varphi_1, \varphi_2, \varphi_3$ and three pseudoeuclidian angles $\theta_1, \theta_2, \theta_3$. This circumstance has required to expand general principle of relativity, having supplemented it by rotary relativity.

The simplest 10-dimensional manifold, describing all degrees of freedom of arbitrary accelerated reference system, appears to be the space, having the geometry of absolute parallelism (Weitzenbock geometry). This geometry is characterized by two metrics: translational (Riemannian metric)

$$ds^2 = g_{ik}dx^i dx^k = \eta_{ab}e^a_i e^b_k dx^i dx^k, \quad \eta_{ab} = \text{diag}(1 - 1 - 1 - 1),$$

$$a, b, c... = 0, 1, 2, 3,$$

and rotary (Killing - Cartan metric)⁴

$$d\tau^2 = -De^a_i De^i_a.$$

in which six independent components of tetrad e^a_i represents the "rotary coordinates".

³We'd notice, that deviation from Coulomb scattering of α - particles on nuclei was observed by E.Reserford [5] in fields $E \approx 10^{16}$ un. SGSE, and at large speeds of electrons the deviation from Coulomb scattering on nuclei was observed by E. Kizinger [6] and R. Hofstadter [7].

⁴In the metric through D the absolute differential with respect to the Christoffel coefficients is designated.

The remarkable property of Weitzenbock geometry is that its torsion

$$\Omega_{jk}^{\cdot\cdot i} = -\Omega_{kj}^{\cdot\cdot i}$$

has a "potential",

$$\Omega_{jk}^{\cdot\cdot i} = e^i_a e^a_{[k,j]} = \frac{1}{2} e^i_a (e^a_{k,j} - e^a_{j,k}) \quad (13)$$

with the tetrad e^a_k playing the its role.

Instead of Einstein equations and equations of general relativity electrodynamics (3) the following equations operate on 10-dimensional manifold

$$R_{jm} - \frac{1}{2} g_{jm} R = \nu T_{jm}, \quad (14)$$

where the energy-momentum tensor of matter

$$T_{jm} = -\frac{2}{\nu} \{ (\nabla_{[i} T^i_{|j|m]} + T^i_{s[i} T^s_{|j|m]}) - \frac{1}{2} g_{jm} g^{pn} (\nabla_{[i} T^i_{|p|n]} + T^i_{s[i} T^s_{|p|n]}) \}, \quad T_{[jm]} = 0 \quad (15)$$

has geometric nature and by means of quantities

$$T^i_{jk} = -\Omega_{jk}^{\cdot\cdot i} + g^{im} (g_{js} \Omega_{mk}^{\cdot\cdot s} + g_{ks} \Omega_{mj}^{\cdot\cdot s}) \quad (16)$$

is determined through torsion (13 of Weitzenbock geometry.

The matter fields (16) behave as a tensor with respect to transformation of translational coordinates, but have nontensor law of transformation with respect to rotary coordinates, that is reflection of rotary relativity.

It is easy to see, that formally the equations (14) are similar to Einstein equations, if one put $\nu = \nu_g = 8\pi G/c^4$, or to equations of general relativistic electrodynamics (3) if one consider $\nu = \nu_e = 8\pi e/mc^4$. On the other hand, the factor ν in equations (14) is reduced after substitution of the ratio (15) in equations (14), therefore field equations (14) originally do not contain any physical constants.

The motion of trial particle in completely geometrized theory is described by ten equations, four of which describe its translational motion

$$\frac{d^2 x^i}{ds^2} = -\Gamma^i_{jk} \frac{dx^j}{ds} \frac{dx^k}{ds} - T^i_{jk} \frac{dx^j}{ds} \frac{dx^k}{ds}, \quad (17)$$

remained six

$$\frac{de^i_a}{ds} = -\Gamma^i_{jk} e^j_a \frac{dx^k}{ds} - T^i_{jk} e^j_a \frac{dx^k}{ds} \quad (18)$$

and its rotation.

Using correspondence between equations (17) and equations of motion in accelerated reference systems one managed to establish [10], that the fields T^i_{jk} , forming matter tensor in completely geometrized equations (14), appears to be the *fields of inertia* creating forces of inertia in accelerated systems. It turned out also, that equations (17) describe motion of

accelerated locally noninertial reference systems, which become inertial provided that force of inertia

$$F_1^i = -mT^i_{jk} \frac{dx^j}{ds} \frac{dx^k}{ds}.$$

It is also possible to show, that though in inertial (and locally inertial) reference systems the forces of inertia are equal to zero, the field of inertia is distinct from zero (due to symmetry properties of inertia field T^i_{jk} , which are determined by the ratio (16)).

This outcome has forced to pay attention to the problem of fields and forces of inertia in theoretical physics, starting from classical mechanics and finishing by modern field theory. It turned out, that this problem been already formulated by I.Newton until now *is the least developed part of modern physics*[11].

The main results obtained as the outcomes of solution of the geometrization problem of matter fields are the following:

- 1) space of events in field theory, taking into account rotary relativity, forms 10-dimensional manifold with the structure of absolute parallelism geometry;
- 2) matter fields are *torsion fields*, being the source of new kind of interactions - torsion ones;
- 3) in inertial reference systems the matter density of point sources, formed by matter field, has a particle-wave nature;
- 4) the problem of motion of particle-wave sources results in wave equations such as Schrodinger ones with arbitrary "quantum constant";
- 5) torsion fields T^i_{jk} generate forces of inertia in the mechanics;
- 6) the accelerated locally inertial reference systems of the second kind are found out and the capability of a mover construction of principally new type is predicted;
- 7) on the base of geometrization of equations (14) the unification of electromagnetic and gravitational interactions was obtained.

In particular, the coulomb - newtonian solution of equations (14) for point particle with mass m and charge Ze is described by the Riemannian metric

$$ds^2 = \left(1 - \frac{2\Psi^0}{r}\right) c^2 dt^2 - \left(1 - \frac{2\Psi^0}{r}\right)^{-1} dr^2 - r^2(d\theta^2 + \sin^2 \theta d\varphi^2) \quad (19)$$

, where

$$2\Psi^0 = r_e + r_g = k \frac{2Ze}{c^2} + \frac{2MG}{c^2} \quad (20)$$

and $k = e/m$ - specific charge of trial particle.

Thus, the geometrization of matter fields has allowed to find out deep connection among:

- a) field structure of particles;
- b) fields of inertia and
- c) wave function of quantum theory.

Now we have the confirmation of intuitive A.Einstein's guesses, that "the perfect quantum theory " will be found on the path of development of the relativity principle.

3 The main principles and equations of the theory of physical vacuum

Achieving the maximum expansion of relativity principle, the author has put forward in 1988 *the principle of universal relativity* [12], which requires relativity of all physical fields and includes translational, rotary (calibration, chiral) and conformal relativity. It has resulted in Einstein program of unified field theory and to putting forward in 1988 the new scientific paradigm - *the program of universal relativity and the theory of physical vacuum* [13] with vacuum equations of the following kind:

$$\nabla_{[k}e^a_{m]} - e^b_{[k}T^a_{|b|m]} = 0, \quad (A)$$

$$R^a_{bkm} + 2\nabla_{[k}T^a_{|b|m]} + 2T^a_{c[k}T^c_{|b|m]} = 0, \quad (B)$$

$$i, j, k... = 0, 1, 2, 3, \quad a, b, c... = 0, 1, 2, 3,$$

allowing also conformal invariance.

The equations (A) and (B) are written in vectorial base, with the matrix e^a_m , T^a_{bm} and R^a_{bkm} being as the main calibration potentials and fields of the theory of physical vacuum. If the complex light tetrad z^a_k [14] connected with a light wave is chosen as the observation system, then the vacuum equations (A) and (B) can be written in spinor base in the form of geometrized system of fundamental physical equations - spinor Heizenberg-Einstein-Yang-Mills equations of the following kind [2]:

Geometrized Heizenberg equations

$$\begin{aligned} \nabla_{\beta\dot{\chi}}o_\alpha &= \gamma o_\alpha o_\beta \bar{o}_{\dot{\chi}} - \alpha o_\alpha o_\beta \bar{l}_{\dot{\chi}} - \beta o_\alpha l_\beta \bar{o}_{\dot{\chi}} + \varepsilon o_\alpha l_\beta \bar{l}_{\dot{\chi}} - \tau l_\alpha o_\beta \bar{o}_{\dot{\chi}} + \\ &+ \rho l_\alpha o_\beta \bar{l}_{\dot{\chi}} + \sigma l_\alpha l_\beta \bar{o}_{\dot{\chi}} - \kappa l_\alpha l_\beta \bar{l}_{\dot{\chi}}, \end{aligned} \quad (\overset{+}{A}{}^{s^+}.1)$$

$$\begin{aligned} \nabla_{\beta\dot{\chi}}l_\alpha &= \nu o_\alpha o_\beta \bar{o}_{\dot{\chi}} - \lambda o_\alpha o_\beta \bar{l}_{\dot{\chi}} - \mu o_\alpha l_\beta \bar{o}_{\dot{\chi}} + \pi o_\alpha l_\beta \bar{l}_{\dot{\chi}} - \gamma l_\alpha o_\beta \bar{o}_{\dot{\chi}} + \\ &+ \alpha l_\alpha o_\beta \bar{l}_{\dot{\chi}} + \beta l_\alpha l_\beta \bar{o}_{\dot{\chi}} - \varepsilon l_\alpha l_\beta \bar{l}_{\dot{\chi}}, \end{aligned} \quad (\overset{+}{A}{}^{s^+}.2)$$

Geometrized Einstein equations

$$2\Phi_{ABC\dot{D}} + \Lambda \varepsilon_{AB} \varepsilon_{\dot{C}\dot{D}} = \nu T_{A\dot{C}B\dot{D}}; \quad (\overset{+}{B}{}^{s^+}.1)$$

Geometrized Yang-Mills equations

$$\begin{aligned} C_{A\dot{B}C\dot{D}} - \partial_{C\dot{D}}T_{A\dot{B}} + \partial_{A\dot{B}}T_{C\dot{D}} + 0(T_{C\dot{D}})_A{}^F T_{F\dot{B}} + (T^+_{\dot{D}C})^{\dot{F}}{}_{\dot{B}} T_{A\dot{F}} - \\ - (T_{A\dot{B}})_C{}^F T_{F\dot{D}} - (T^+_{\dot{B}A})^{\dot{F}}{}_{\dot{D}} T_{C\dot{F}} - [T_{A\dot{B}}, T_{C\dot{D}}] = -\nu J_{A\dot{B}C\dot{D}}, \end{aligned} \quad (\overset{+}{B}{}^{s^+}.2)$$

$$\alpha, \beta... = 0, 1, \quad \dot{\chi}, \dot{\mu}... = \dot{0}, \dot{1}; \quad A, C... = 0, 1, \quad \dot{B}, \dot{D}... = \dot{0}, \dot{1},$$

which describe potential state of all kinds of matter, and their solutions created from vacuum are not pairs of particles but Terletckiy's quadrig [15].

The main properties of equations of vacuum are as follows:

1) they do not contain any physical constants, since vacuum can not be characterized by something particular;

2) completely geometrized equations (14) follow from vacuum equations, giving the solution to Einstein program of unified field theory;

3) the solutions of vacuum equations have three-fold character, describing particles and fields, which moves with up to light, light and superlight speeds;

4) the equations predict the existence of *primary torsion fields* which:

- have zero energy-momentum tensor,
- infinite propagation speed,
- high penetrating ability,
- change energy of a system in bound state;

5) solutions of the equations describe vacuum excitation possessing gravitational, electromagnetic, weak, quarkian and others yet not identified interactions.

4 Superpotential and its properties

To find any solution of vacuum equations is possible with the help of method of Newman-Penrose spin factors [10], though it would be correct to speak about construction of solutions of vacuum equations [2].

In designations adopted in [10] the solution of vacuum equations leading to superpotential has the form

(21)

1) Coordinates: $x^0 = u$, $x^1 = r$, $x^2 = \theta$, $x^3 = \varphi$;

2) Components of Newman-Penrose coefficients:

$$\sigma_{00}^i = (0, 1, 0, 0), \quad \sigma_{11}^i = \rho\bar{\rho}(\Sigma, -\Pi, 0, r_s),$$

$$\sigma_{0i}^i = -\frac{\bar{\rho}}{\sqrt{2}}(ir_s \sin \theta + 2ir_N \operatorname{ctg} \theta, 0, 1, i \operatorname{cosec} \theta), \quad \sigma_{10}^i = \overline{\sigma_{0i}^i},$$

$$\Sigma = r^2 + r_N^2 + r_s^2, \quad \Pi = (r^2 - r_N^2 + r_s^2 - 2\Psi^0 r)/2,$$

$$r_N = \operatorname{const}, \quad r_s = \operatorname{const}, \quad 2\Psi^0 = r_e + r_g = \operatorname{const};$$

3. Spinor components of Ricci rotation coefficients:

$$\rho = -(r + ir_N - ir_s \cos \theta)^{-1}, \quad \beta = \bar{\rho}\beta^0, \quad \pi = \rho^2\bar{\tau}^0,$$

$$\alpha = \rho\alpha^0 + \rho^2\bar{\tau}^0, \quad \tau = \rho\bar{\rho}\tau^0,$$

$$\mu = \rho/2 + \rho\Psi^1/2 + \rho\bar{\rho}\bar{\Psi}^1/2 + \rho^2\bar{\rho}\tau^0\bar{\tau},$$

$$\gamma = \rho^2\Psi^1 + \rho\bar{\rho}(\tau^0\alpha^0 + \bar{\tau}^0\beta^0) + \rho^2\bar{\rho}\tau^0\bar{\tau}^0,$$

$$\Psi^1 = \Psi^0 + ir_N,$$

$$\bar{\alpha}^0 = -\beta^0, \quad \beta^0 = -\frac{1}{4}(2)^{1/2}\text{ctg } \theta, \quad \tau^0 = -\frac{1}{2}ir_s(2)^{1/2}\sin \theta;$$

4. Spinor components of Riemann tensor:

$$\Psi_2 = \Psi = \Psi^1\rho^3.$$

Distinct from zero the metric tensor components g_{ij} have the form

$$\begin{aligned} g_{uu} &= \rho\bar{\rho}(r^2r - r_N^2 + r_s^2 \cos^2 \theta), \\ g_{ur} &= 1, \\ g_{u\varphi} &= -2\rho\bar{\rho}r_N \cos \theta \Pi + 2\rho\bar{\rho}r_s \sin^2 \theta (\Psi^0 r + r_N^2), \\ g_{r\varphi} &= -r_s \sin^2 \theta - 2r_N \cos \theta, \\ g_{\theta\theta} &= -r^2 - (r_N - r_s \cos \theta)^2, \\ g_{\varphi\varphi} &= \rho\bar{\rho}\Pi(r_s \sin^2 \theta + 2r_N \cos \theta)^2 - \rho\bar{\rho} \sin^2 \theta \Sigma^2. \end{aligned} \quad (22)$$

The potential energy of interaction of island type systems, with its field vanishing at infinity, is calculated under the formula [2]

$$U = T - L = -mc \left[\left(\eta_{ik} \frac{dx^i}{dt} \frac{dx^k}{dt} \right)^{1/2} - \left(g_{ik} \frac{dx^i}{dt} \frac{dx^k}{dt} \right)^{1/2} \right], \quad (23)$$

where $\eta_{ik} = \text{diag}(1 - 1 - 1 - 1)$ - metric tensor of flat space.

For qualitative research of potential energy it is enough to use the approximate non-relativistic formula

$$U = \frac{mc^2}{2}(g_{00} - 1). \quad (24)$$

As a rule, this simple formula allows to determine the main tendency of researched interaction. The solution (21) with metric tensor (22) describes vacuum excitation with potential energy of interaction of the kind

$$U = -mc^2 \frac{\Psi^0}{r} \left[1 + \frac{r}{\Psi^0} \frac{r_N^2 - r_N r_s \cos \theta}{r^2 + (r_N - r_s \cos \theta)^2} - \frac{(r_N - r_s \cos \theta)^2}{r^2 + (r_N - r_s \cos \theta)^2} \right], \quad (25)$$

in which the constant $2\Psi^0 = r_e + r_g$ is responsible for coulomb - newtonian part of interaction, with the inequality being, as a rule, executed for elementary particles

$$|r_e| \gg r_g. \quad (26)$$

Constants r_N and r_s in (25) determine the short-range additions to Coulomb - Newtonian potential energy $U_0 = -mc^2\Psi^0/r$, and θ - angle between an axis z and position vector \mathbf{r} .

From the solution (21) it follows, that r_N determines the imaginary part of the complex source function

$$\Psi^1 = \Psi^0 + ir_N, \quad (27)$$

i.e. the imaginary part of mass or charge, while r_s describes mechanical rotation of a source of spin - vacuum excitation.

4.1 Fundamental approach to the description of strong interactions

The potential energy (25) has all properties of fundamental description of strong interactions, namely:

a) it has the short-range additions to coulomb - newtonian interaction decreasing with distance from source as $1/r^2$ and $1/r^3$;

b) it has no charge dependence, since when the charge of a source is zero (and under condition of (26)) it gets the form

$$U = -mc^2 \frac{r_N^2 - r_N r_s \cos\theta}{r^2 + (r_N - r_s \cos\theta)^2}; \quad (28)$$

c) it has strong dependence upon a direction of the source spin;

d) it contains the short-range addition of torsion nature causing repulsion on small distances and explaining the property of saturation of nuclear forces.

The value of Coulomb - Newtonian constants in (25) is determined on the base of correspondence principle with Maxwell-Lorentz and Einstein equations. The ratio (20) gives their form. When solving quantum problems it is convenient to present electromagnetic radius as

$$r_e = \pm 2Zz\alpha \frac{h}{mc}, \quad (29)$$

where the sign "-" corresponds to attraction, and "+" - to repulsion between charge of trial particle ze and charge of source Ze and $\alpha = e^2/hc$ - constant of thin structure. For example, when solving the problem of proton elastic scattering on copper nuclear the calculation under the formula (29) gives

$$r_e^{(Cu-p)} = 0,89 \times 10^{-14} \text{cm}.$$

There are no fundamental equations to determine constants r_N and r_s through correspondence principle, therefore the estimation of these constants magnitude one could do theoretically or because of analysis of experimental data on elastic scattering of neutrons and protons (or other elementary particles) on nuclei of different elements.

From the structure of potential energy (25) one could see, that to make the constants r_N and r_s significant influence upon its change they should have magnitude of the same order as r_e .

In fig.1 the drawings of potential energy dependence (25) upon r_N, r_s and upon orientation of three-dimensional spin of field source are shown at specific r_e .

To determine r_N from experimental data A. Sidorov and E.A. Goubarev have carried out [8] the comparison of theoretical calculations of elastic scattering of neutrons and protons on nuclei of various elements with use of potential energy (25). Under conditions $r_s = 0$ and

$$U = -mc^2 \frac{\Psi^0}{r} \left[1 + \frac{r}{\Psi^0} \frac{r_N^2}{r^2 + r_N^2} - \frac{(r_N)^2}{r^2 + r_N^2} \right],$$

the classical problem of elastic scattering was solved.

In fig 2 the experimental points of differential cross-section of neutrons scattering with kinetic energy 3, 7 Mev on nuclei of iron and theoretical curve with $r_e = 0, r_N = 0,56 \times 10^{-14} \text{sm}$ are submitted [16].

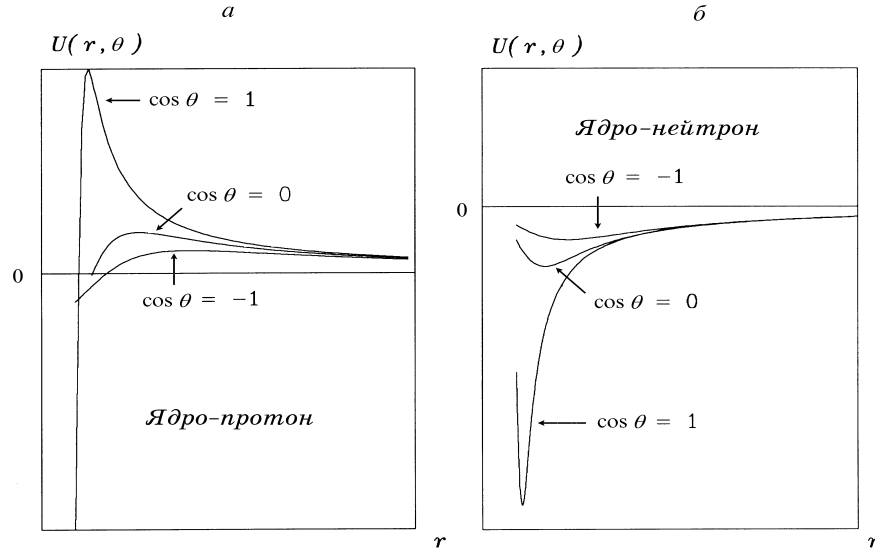

Figure 1: The drawings of potential energy dependence from spin orientation: *a* - potential energy of protons scattering on polarized target with $r_e/r_N = -2$, $r_N/r_s = 1,5$; *b* - the same for neutrons with $r_e/r_N = 0$, $r_N/r_s = 1,5$

The acute peak on the curve is explained by cross-section of particles scattering, which have made more than one turnover around scattered center.

From the obtained value of nuclear radius r_N , determining the "horizon of events" at $r_e = 0$, it is possible to estimate the radius of nuclear forces influence R_N as

$$R_N \sim (10 - 20)r_N \sim 10^{-13} sm, \quad (30)$$

that corresponds to conventional estimations.

The comparison of theoretical curve of differential cross-section of scattering on small angles, calculated for not charged particles, with the experimental data on scattering neutrons on nuclei of various elements has enabled to determine the magnitude of the constant r_N . It has appeared, that $r_N = 0.56 \times 10^{14} sm$.

In fig. 2 it is visible, that the theoretical value of elastic cross-section of classical particles scattering coincides with experimental cross-section only on small scattering angles, for which classical and quantum scattering descriptions give the identical outcomes.

Quantum scattering theory of particles was constructed for description of scattering on large angles [17, 18]. From comparison of quantum cross-section of non-charged particles scattering with the experimental data the r_N values for various elements were determined [17]. It was established, that the empirical law of nuclear physics is observed.

$$r_N \sim A^{1/3}, \quad (31)$$

where A - mass nuclear number, with "nuclear radius" r_N not depending on energy of scattered particles.

The value r_N determined from the solution of quantum problem (defined more exactly after publication [17]) was used then in the problem of cross-section calculation of quantum

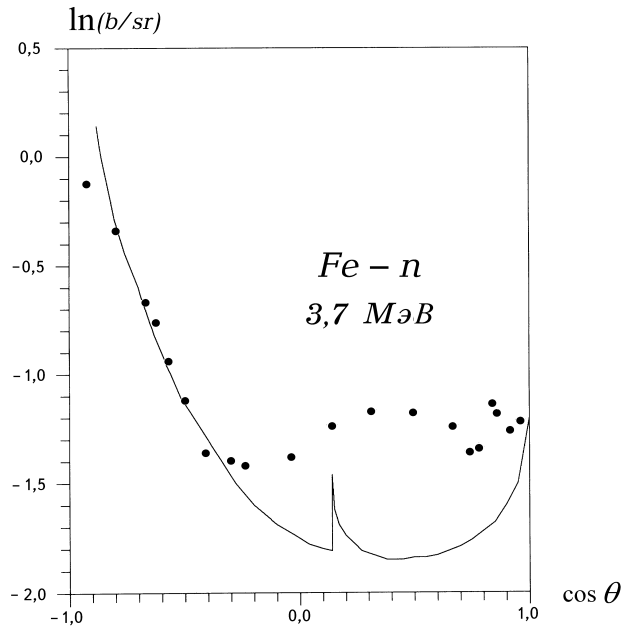

Figure 2: Classical scattering of nonrelativistic neutrons with energy 3,7 Mev on nuclei of iron

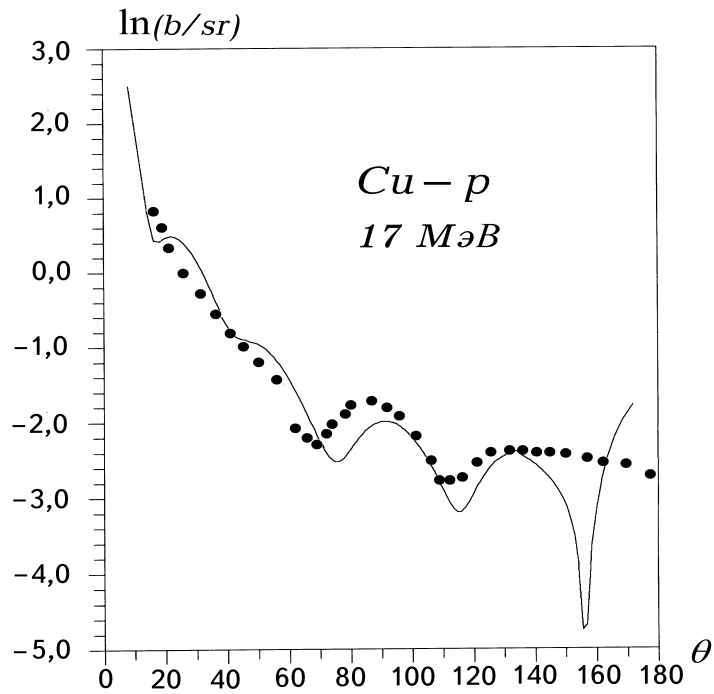

Figure 3: Elastic scattering of protons with energy 17 Mev on the copper nuclei

particle scattering interacting with field source by the electronuclear way ($r_e \neq 0$, $r_N \neq 0$). The r_e values were determined from the formula for the electromagnetic radius, which for scattered protons has the following form: $r_e = -2Z\alpha h/m_p c$, where $r_e = -2Z\alpha h/m_p c$, - proton mass.

In fig. 3 the theoretical curve represents [19] a differential scattering cross-section of charged quantum particle with rest energy 938,5 Mev, kinetic energy 17 Mev. The parameter $\delta = r_N m c / h = 0,15$, that corresponds to $r_N = 0,315 \times 10^{-14}$ sm, parameter $G = r_e / r_N = -2,8$, that corresponds to $|r_e| = 0,89 \times 10^{-14}$ sm. Experimental points are differential cross-section of protons elastic scattering with energy 17 Mev on copper nuclei [20].

Thus, the results have shown good correspondence between the experimental and theoretical data in quantum picture of scattering particles possessing nuclear interaction. Besides that the theory allows to base experimentally observed relation (31). It gives us the right to assert, that the potential energy (25), obtained from the solution (21) of vacuum equations (A) and (B), describes nuclear and electronuclear interactions.

It seems that even more perspective for description of nuclear interactions is the potential energy with radius r_s , responsible for three-dimensional rotation of source - "rotary radius". Such fundamental properties of nuclear interactions as dependence upon spin and nontensor character of interaction are described (while qualitative) by radius r_s .

The potential energy (25) submits broad possibilities for fundamental description of interactions in microcosms and allows to assume, that some experimental effects seeming anomalous for conventional phenomenological theories can be interpreted within the framework of the theory of physical vacuum. For example, it is A.Crish data [21], showing significant left-hand and right-hand asymmetry in proton scattering with high energy on polarized proton target.

4.2 Probable approach to fundamental description of weak interactions

Processes with participation of neutrino are usually implied by weak interactions. The simplest one is "pure" β decay of neutron according to the scheme



where p - proton, e^- - electron and $\bar{\nu}$ - antineutrino.

From experimental data on scattering electrons on nuclei and on protons it is known, that electron hasn't nuclear interaction, therefore it was not clear, how electron is kept by proton on distance $\sim 10^{-13}$ sm, forming neutron. Besides that during decay of a system consisting of charged particles, the γ -quanta instead of hypothetical antineutrino should be radiated.

If particles have no nuclear interaction, then $r_N = 0$ and the potential energy (25) gets the form

$$U = -m c^2 \frac{\Psi^0}{r} \left[1 - \frac{r_s^2 \cos^2 \theta}{r^2 + r_s^2 \cos^2 \theta} \right]. \quad (33)$$

It is supposed, that torsion parameter r_s for elementary particles coincides with Compton wavelength of the source. In particular, for proton we have

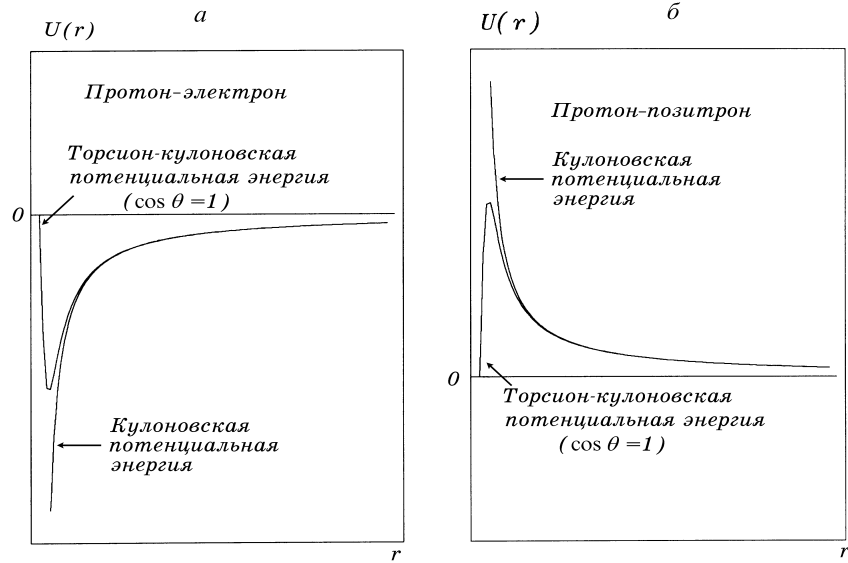

Figure 4: Potential energy of polarized protons: *a* - potential energy of interaction between electron and proton with $r_e/r_s = 26,8$; *b* - the same with positron

$$r_s = \lambda_p = \frac{h}{m_p c} = 2,108 \times 10^{-14} \text{ sm.} \quad (34)$$

Since for proton - electron interacting system in potential energy (33) $2\Psi^0 = r_e = 2e^2/mc^2 = 5,6 \times 10^{-13} \text{ sm.}$, then $r_e/r_s = 26,8$.

The qualitative drawings of potential energy (33) for interaction of proton with electron and positron are shown in fig. 4.

From the drawing it is visible, that on distance about r_s from the center of proton there is bottom of "torsion hole", in which electron "slips", when it forms neutron together with proton. The depth of this hole depends very strongly on orientation of three-dimensional spin of proton (the hole disappears when $\cos \theta = 0$), and therefor due to vacuum fluctuations the connection of electron with proton appears to be unstable. Besides that when reaching proton, torsion repulsive forces increase and begin to predominate above Coulomb forces of attraction. It seems, that these circumstances explain instability of free neutron, and also continuous spectrum of electron energies during its decay.

The suggested model of neutron considers neutrino as radiation of zero-mass torsion field, arising when electron is coming out of the torsion hole. It is especially important to note, that torsion potential energy (33) vanishes, when $r_e = 0$. It means, that free torsion radiation passes through material medium without interaction. Thus, neutrino represents a kind of material torsion field, carrying energy but not interacting (or weakly interacting) with usual matter. It is possible now to explain high penetrating ability of neutrino by equality to zero of potential energy of purely torsion radiation.

4.3 The problem of formfactors and saturation of nuclear forces

Studying electrons scattering, E.Kinzinger [6] and R.Hofstadter [7] have found out a devi-

ation from coulomb interaction at elastic scattering of electrons on nuclei (the deviation from Mott formula [22]).

Since Coulomb potential is generated by point charge, R.Hofstadter [7] has suggested to simulate anomalous electrons scattering by introducing of some phenomenological distribution of nuclear charge distinct from point one. Thus, the scattering of electrons begin to depend on the shape of charge distribution in nuclear. The explicit shape of charges distribution is introduced into the theory artificially, since there are no fundamental equations, from which it can be received. For example, one of many phenomenological charge distributions used in the theory of electromagnetic shape factors [23] has the form

$$\rho(r) = \frac{\rho_0}{1 + \exp((r - R)/a)}.$$

This two-parameter distribution is used for description of scattering on heavy nuclei. The distributions parameters are not once and for all established constants for one kind of nuclei and depend on external conditions, for example, from range of energy of scattered electrons. Therefore theory of electromagnetic shape factors is, as well as modern theory of nuclear forces, a descriptive theory.

Fundamental approach in theory of electromagnetic shape factors is possible on the base of potential energy (33). From experiments follows, that on small distances between proton (or nuclei) and electron there is a repulsion, which is interpreted as existence of proton kernel.

From fig. 4 it is visible, that during the interaction of electrons with protons or others positively charged particles, for example, with nuclei on small distances there arise repulsive force induced, as it is seen from (33), by spin of the source. Therefore at elastic scattering of electrons on protons and nuclei the deviation from coulomb type scattering on small distances should be observed.

The same repulsive forces allow (while qualitative) to explain saturation of nuclear forces. The thing is that number of uniformly spin oriented nucleons in nucleus of heavy elements can be large enough and "spin charge" for N identically spin oriented nucleons

$$S = Nr_s,$$

is such, that repulsion "torsion force" in the potential energy (25) predominates above nuclear forces of attraction.

5 Torsion field and interactions

The remarkable corollary of the theory of physical vacuum has been appeared the discovery of new physical field (16), called torsion because it describes rotary matter properties. Torsion field is generated by torsion of Weitzenbock space (13) and generally has 24 independent components. Besides that the tensor of torsion Ω_{jk}^i is decomposed to sum of three irreducible parts: vector Ω_j , pseudovector $\hat{\Omega}_j$ and traceless part of torsion $\bar{\Omega}_{jk}^i$, - defining as

$$\begin{aligned} \Omega_j &= \Omega_{.ji}^i, & \hat{\Omega}_j &= \frac{1}{2} \varepsilon_{jins} \Omega^{ins}, \\ \bar{\Omega}_{.js}^s &= 0, & \bar{\Omega}_{ijs} + \bar{\Omega}_{jsi} + \bar{\Omega}_{sij} &= 0. \end{aligned}$$

At transition to spinor Δ -basis the spinor representation of torsion field T^i_{jk} has the following form [2]

$$T_{ABC\dot{C}} = \frac{1}{2} \left(A_{ABC\dot{C}} + \frac{1}{3} (\varepsilon_{AC} \alpha_{B\dot{C}} + \varepsilon_{BC} \alpha_{A\dot{C}}) \right),$$

$$A, C \dots = 0, 1, \quad \dot{B}, \dot{D} \dots = \dot{0}, \dot{1},$$

where spinor $A_{ABC\dot{C}}$ is completely symmetrical in the unprimed indices:

$$A_{ABC\dot{C}} = A_{(ABC)\dot{C}},$$

and spinor $\alpha_{B\dot{C}}$ can be decomposed on Hermitian and anti-Hermitian parts:

$$\alpha_{A\dot{C}} = \kappa_{A\dot{C}} - i\mu_{A\dot{C}}.$$

The spinor $A_{ABC\dot{C}}$ is transformed according to $D(3/2.1/2)$ indecomposable representation of group $SL(2.C)$ and describes torsion field of spin $3/2$. Accordingly, spinors $\kappa_{A\dot{C}}$ and $\mu_{A\dot{C}}$ are transformed according to $D(1/2.1/2)$ indecomposable representation of group $SL(2.)$, with spinor $\kappa_{A\dot{C}}$ corresponding to torsion field with spin 1, and spinor $\mu_{A\dot{C}}$ to spin $1/2$.

In completely geometrized field equations (14) the energy-momentum tensor T_{kn} is determined through torsion field according to the ratio (15). Limiting by inertial reference system, we discover, that the field T^i_{jk} is antisymmetric on all three indexes and thus the tensor (15) will be written as [2]

$$T_{jm} = \frac{1}{\nu} \left(\hat{\Omega}_j \hat{\Omega}_m - \frac{1}{2} g_{jm} \hat{\Omega}^i \hat{\Omega}_i \right).$$

or in spinor form

$$T_{A\dot{B}C\dot{D}} = \frac{1}{\nu} \left(\mu_{A\dot{B}} \mu_{C\dot{D}} - \frac{1}{2} \varepsilon_{AC} \varepsilon_{\dot{B}\dot{D}} \mu_{P\dot{Q}} \mu^{P\dot{Q}} \right).$$

Therefore in an inertial reference system the "density of spinor substance" is expressed through four components of torsion field with spin $1/2$ and has the following form [2]:

$$\rho = -\frac{1}{\nu c^2} \mu_{P\dot{Q}} \mu^{P\dot{Q}}. \quad (35)$$

On the other hand, the solution of equations (14), causing non-stationary coulomb-newtonian potential, gives point distribution of substance in limit transition to stable state [2]

$$\rho = \frac{8\pi\Psi^0}{\nu c^2} \delta(\mathbf{r}). \quad (36)$$

The ratio (35) and (36) indicate a particle-wave dualism of vacuum excitations, which origin is connected to the field nature of stable particles.

Using designation of Newman-Penrose formalism [14] it is possible to represent the spinor $\mu_{A\dot{C}}$ as

$$\mu_{A\dot{C}} = i/2 \begin{pmatrix} (\rho - \bar{\rho}) - (\varepsilon - \bar{\varepsilon}) & (\tau - \beta) - (\bar{\alpha} - \bar{\pi}) \\ -(\bar{\tau} - \bar{\beta}) + (\alpha - \pi) & (\gamma - \bar{\gamma}) - (\mu - \bar{\mu}) \end{pmatrix}.$$

Here $\mu, \gamma, \beta, \dots$ - spinor components of torsion field. In the case of weak torsion fields there is a possibility to use for studding of spinor $\mu_{A\dot{C}}$ components behavior the wave analysis [2], with:

- a) Hilbert space of states,

b) optic-mechanical analogy,

c) indeterminacy principle appearing to be a corollary of linear approximation at the description of motion of purely field objects, possessing particle-wave dualism (35)-(36).

The occurrence of stable state at motion, for example, of charges in central forces field is explained by existence of accelerated locally Lorentzian reference systems in electrodynamics, and quantum character of electron energy is connected to refusal of trial particle concept (without the account of its own field). Quantum particle is an extended object, which motion in limited space naturally results in discrete spectrum of possible states.

In linear nonrelativistic approximation the motion problem of substance density (35) is reduced to the solution of equations of Schrodinger type

$$ic_1 \frac{\partial \psi}{\partial t} + \frac{c_1^2}{2m} \nabla^2 \psi + U(r)\psi = 0 \quad (37)$$

with arbitrary "quantization constant" c_1 . In this equation wave function ψ represents one of the components of torsion field $\mu_{AC\cdot}$, normalized on unit. Hence, "quantum mechanics" of vacuum excitations, based on equation (37), in linear approximation describes dynamics of torsion fields.

Torsion fields are divided on static and dynamic. Static torsion fields arise at rotation of objects with constant angular momentum and their description is connected with torsion additions to potential interaction energy. The example of static torsion field is the field induced by spin of electron or any other elementary particle and causing potential energy of the type (33)).

Besides torsion fields are divided on primary and secondary. Primary torsion fields are generated by torsion of space with zero Riemannian curvature, with their energy-momentum tensor being initially equal to zero. Such fields are material, but are not usual substance.

Secondary torsion fields, fields of inertia, are connected to substance through their inertial properties. Their description is given by equations of quantum field theory (in nonrelativistic case by equations of Schrodinger type (37)). It turns out that neutrino is the example of secondary torsion field, which equation (Weil equation) is written as

$$\gamma^i \partial_i \Psi = 0 \quad (38)$$

where Ψ - spinor Dirac field, and γ^i - gamma-matrixes

$$\gamma_0 = \begin{pmatrix} I & 0 \\ 0 & -I \end{pmatrix}, \quad \gamma_\alpha = \begin{pmatrix} 0 & -\sigma_\alpha \\ \sigma_\alpha & 0 \end{pmatrix},$$

connected through Pauli matrixes σ_α to a spin s_α as

$$s_\alpha = \frac{h}{2} \sigma_\alpha, \quad \alpha = 1, 2, 3.$$

As it was noticed earlier, (anti)neutrino is formed during neutron decay, when the electron comes out from "torsion hole" (see fig. 4a), formed by spin of proton. The spin of proton creates inside the neutron a short-range static field. At the moment of the neutron decay dynamic torsion field is formed - (anti)neutrino, carrying only spin.

5.1 Static torsion field

There are two types of static torsion fields:

- 1) torsion fields created by geometry of an object;
- 2) fields generated by stationary rotation of an object.

Basing on phiton vacuum model, A.Akimov has predicted the possibility of vacuum polarization on spin [24]. Later it was experimentally established, that a geometric surfaces made of various materials polarize vacuum on torsion field, simultaneously creating right-hand and left-hand torsion fields. It is possible to explain this process by decomposition of vacuum on right-hand and left-hand vacuum torsion polarizations, with right-hand T_{jk}^+ and left-hand T_{jk}^- torsion fields being connected by the ratio [2]

$$T_{jk}^+ + T_{jk}^- = 0.$$

The experiments show [24], that torsion polarization of vacuum can be created artificially, having located in vacuum any material object. For example, hollow cone made of any material creates torsion polarization [25], shown on fig.5.

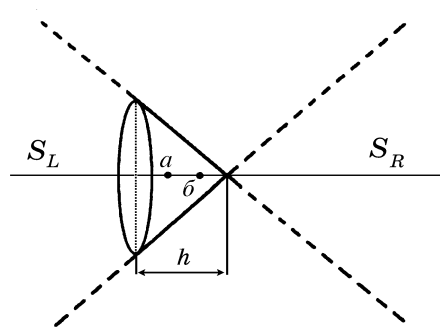

Figure 5: Torsion polarization of vacuum created by a cone. The points a and b designate maxima of left-hand torsion field S_L

The directional diagram, the points of maxima and chirality of static torsion field were determined according to the effect of torsion polarization on objects, in which there were processes with spin polarization, for example, crystallization of micellar structures [25]. This effect received the name "effect of forms" is described by many investigators [26, 27] and even is patented [28, 29].

5.1.1 Macroscopic torsion fields

Stable torsion fields created by rotation of macro-objects are described, for example, by the solution (21). If a homogeneous spherically symmetrical mass M rotates around an axis z with constant angular frequency ω , then nonrelativistic potential energy of its interaction with a trial particle with mass m has the form

$$U = -\frac{mMG}{r} \left[1 - \frac{r_s^2 \cos^2 \theta}{r^2 + r_s^2 \cos^2 \theta} \right]. \quad (39)$$

If one expresses the parameter of rotation r_s through its own angular momentum of rotation L of mass M as

$$r_s = \left(\frac{5L}{2M\omega} \right)^{1/2},$$

then one can see, that torsion addition to Newtonian potential energy at distances $r > r_s$ is determined by the radius r_s , and is maximum along the axis z and vanishes in the equatorial plane of rotated body. Because of nonrelativistic character and due to skilful statement of experiment the formula (39) can be checked in laboratory conditions. For this purpose it is necessary to find a reliable way of record of macroscopic torsion fields.

5.1.2 Microstatic torsion fields

The source of Microstatic torsion field is the spin of elementary particle. For electron this quantity is measured by half-integer number of Plank constants

$$s_z = \pm \frac{h}{2}. \quad (40)$$

Since the electron has charge, then its own rotation generates magnetic moment of the electron⁵.

$$\mathbf{M} = -\frac{e}{mc}\mathbf{s}. \quad (41)$$

Taking into account, that $r_s = h/mc$, and using the formulas (40) and (41), we get the following ratio

$$r_s = \frac{2}{e}M_B, \quad (42)$$

where $M_B = \pm(eh)/2mc$ - Bohr magneton. These ratios indicate deep relation between magnetic and torsion phenomena in microcosms. Moreover, Einstein and De Gaas experiment is actually the first torsion experiment, connecting macroscopic rotary (i.e. torsion) mechanical phenomena with quantum microscopic ones.

It is known from quantum theory of atom, that the existence of spin of electron splits the power levels of electron in external magnetic field (Zeeman effect) due to interaction of magnetic moment (41) with magnetic field. This interaction happens on distances about 10^{-8} sm from nucleus center. On the other hand, torsion field of nucleus operates (according to (34) and (39)) on distances about 10^{-14} sm. Therefore torsion nucleus corrections to power levels in atom have the order comparable to the corrections, obtained due to the electromagnetic shape factors of nucleus.

The ratio (41) indicates, that the intensive source of torsion static field is the magnets, in which not only unidirectional magnetic moment of separate atoms, but also their torsion fields are sum up. This theoretical reasoning is confirmed by numerous experiments [24].

5.2 Dynamic torsion fields of the second kind

The majority of equations of quantum field theory describe dynamics of torsion fields (fields of inertia) or their potentials. Besides that such fields arise due to change of orientation or magnitude of own angular momentum of an object and allow both quantum and classical description.

⁵The sign $-$ is connected whit the charge of electron, which, as known, is negative.

5.2.1 Macroquantum torsion fields

According to purely field equations (14), the energy-momentum tensor of any substance is expressed through torsion fields, which are physically interpreted as fields of inertia. The inertia is the most universal property of matter, therefore it is not surprising, that Schrodinger equations (37), which describes dynamics of fields of inertia in the simplest way, is also successfully applicable for study of electromagnetic, nuclear, weak and other interactions both of micro, and macrocosms.

It was shown earlier, that the neutrino equation (38) represents an example of torsion field becoming apparent in microcosms. In macrocosms quantum torsion fields allow to describe motion of planets. For example, it is possible to substantiate the description of motion of gravitating objects (planets of solar system) with the help of quantum equation (37), in which the normalized field of inertia enters as wave function Ψ , by that the field of inertia characterizes any substance in universal manner. Since a planet is formed not only of substance, which mass of the planet consists of, but also of its gravitational field, then it is due to this universality of inertia fields the possibility appears to study the motion of planet as integral extended object, in view of its own gravitational field.

These simple reasons allow to construct quantum model of Solar system similar to the nuclear one, using dynamics of inertia fields, especially as the experimental data on the discrete structure of Solar system are well known [30, 31].

The equation (37) allows to give the theoretical substantiation of the observable data. Indeed, if one applies the equation (37) to description of motion of planets around Sun, then from this equation the well-known half-classic formula (Bohr formula) for angular momentum quantization of planets follows

$$p = mvr = c_1(n + 1/2), \quad n = 1, 2, 3, \dots, \quad (43)$$

where m - mass of planet, v - its velocity and r - average distance up to Sun. From here we discover the quantum formula for r of the following kind

$$r = r_0(n + 1/2) \quad n = 1, 2, 3, \dots, \quad (44)$$

where $r_0 = c_1/mv$ - de Broglie wavelength of planet, which for all planets appears to be equal to 0,2851 a.u.⁶

The average distances calculated according to the formula (44) are shown in tab. 1. As we see, the formula (44) describes the discontinuous distribution of substance in Solar system well enough.

The difference between quantization of Solar system and quantization of nuclear systems is that in atom the electrons have identical masses and charges, while the planets have different masses. Besides that from the formula (43) it follows, that quantum "constant" c_1 for planets takes different values. This obvious absence of universality, intrinsic to nuclear physics, requires further researches, which, probably, cause that planets masses "will be quantized" and, most likely, be expressed through mass of the lightest planet⁷.

⁶This constant is determined by analysis of experimental data.

⁷In Solar system the angle of declination of rotation axis of planets to equator plane of Sun is quantized also, with the cosine of declination angle taking values close to 0, 1/2 and 1.

Table 1:

Planet	n	r_t	r_e	Δr
Mercury	1	0,43	0,39	-0,04
Venus	2	0,71	0,72	+0,01
Earth	3	1,00	1,00	0,00
1A	4	1,28	1,28	0,00
Mars	5	1,56	1,52	-0,04
1B	6	1,85	1,89	+0,04
1	8	2,42	2,40	-0,02
2	9	2,71	2,68	-0,03
3	10	2,99	3,02	+0,03
Jupiter	18	5,27	5,20	-0,07
Hidalgo	20	5,84	5,82	-0,02
Saturn	33	9,55	9,54	-0,01
Uranus	67	19,24	19,19	-0,05
Neptune	105	30,08	30,07	-0,01
Pluto	138	39,49	39,52	+0,03

5.2.2 Electrotorsion radiation

Classical description of torsion interactions is possible by means of six rotary equations (18), which before appearance of the theory of physical vacuum were not known in science. These equations describe change of orientation of rotated object during its motion in external (electromagnetic, gravitational etc.) fields. Using the equations (18), it is possible to show, that in three-dimensional approximation the own rotation of object is connected to the third derivative of coordinate on time [32]. In electrodynamics the third derivative enters in equations of motion,

$$m\ddot{\mathbf{x}} = e\mathbf{E} + \frac{e}{c}[\dot{\mathbf{x}}\mathbf{H}] + \frac{2e^2}{3c^3}\ddot{\mathbf{x}}, \quad (45)$$

including the force of radiative friction $\mathbf{F}_{rad} = (2e^2/3c^3)\ddot{\mathbf{x}}$.

Passing in equations (18) to three-dimensional representation⁸ and choosing as parameter time t , we find with their help the following expressions for force of radiative friction

$$\mathbf{F}_{rad} = \frac{2e^2}{3c^3}\left\{\left(\frac{d\kappa}{dt}\mathbf{e}_2 - \kappa^2\mathbf{e}_1 + \kappa\chi\mathbf{e}_3\right)v^3 + 3(-\kappa\mathbf{e}_1 + \chi\mathbf{e}_3)va + \frac{da}{dt}\mathbf{e}_1\right\}, \quad (46)$$

where κ and χ - curvature and torsion of charge trajectory, v and a - its velocity and acceleration, $\mathbf{e}_1, \mathbf{e}_2, \mathbf{e}_3$ - vectors of Frene triad.

It is visible from these equations, that the force of radiative friction has complex structure, with it containing terms generated not only by electromagnetic (determined by curvature κ), but also torsion (dependent on torsion χ) interactions. Indeed, the third and fifth terms in right part of equality (46) contain torsion χ , therefore *accelerated particle with spin radiates*

⁸The tree-dimensional part of equations (18) represents well known Frene equations [32].

both electromagnetic, and torsion fields. This theoretical conclusion is confirmed excellently by numerous experimental facts [24].

Basing on the ratio (46), it is possible to produce approximate evaluation of magnitude of electrotorsion interaction force and to compare it with forces of electromagnetic and gravitational interactions. For an electron, which radiates near to the first circular Bohr orbit ($E \approx 10^8$ V/sm), it is easy to calculate the force of electromagnetic \mathbf{F}_e and gravitational \mathbf{F}_g interactions of electron with the nucleus:

$$F_e = \frac{e^2}{r_0^2} \approx 4,8 \times 10^{-2} \text{ din},$$

$$F_g = \frac{\gamma m M_{\text{Я}}}{r_0^2} \approx 0,6 \times 10^{-42} \text{ din}.$$

From the equality (46) for electrotorsion interaction force in our case we find out the estimated value of electrotorsion interaction force

$$F_{\text{ex}} \approx 2,9 \times 10^{-4} \text{ din}.$$

Thus, *the force of electrotorsion radiation of electron in the nucleus appears to be weaker than the electrostatic force and stronger than the force of gravitational interaction*, that also is observed in experiment [24].

Guiding by these conclusions, it is possible to assume the following scheme of the simplest generator of torsion radiation (fig. 6), realized by A.E.Akimov [24]. Inside grounded metal body 1 there is a generator of electromagnetic oscillations G with changing frequency of own oscillations⁹. The output contour 3 has the condenser C and inductance L . In the condenser C instead of dielectric the ferromagnetic 4 is used. Changing polarity on the condenser facings, we force electrons of the ferromagnetic to change orientation of spins, that generates electrotorsion radiation. During activity of the generator outside the grounded metal body there is only electrotorsion component, since the electromagnetic part of radiation is cut off due to shielding. The torsion radiation is formed by the cone 5. It is clear, that the frequency of radiated torsion signal coincides with frequency of the setting generator. Change of electromagnetic oscillations frequency of the setting generator 2 results in change of frequency of output torsion signal, therefore the control by the torsion generator is implemented with the help of electromagnetic fields. In fig. 7 one of Akimov generators is shown, widely used in torsion experiments.

Now in Russia there are developed and produced torsion generators with broad set of adjustable parameters. Such generators allow smooth change of torsion frequencies, introduction of modulations of various types, capability to generate right-hand (S_R) and left-hand (S_L) torsion fields, to execute a slide control of "intensity" of output torsion signal etc. In generators every possible working media are used as sources of torsion signal: flows of electrons, plasma, ferromagnetic and etc.

5.3 Primary torsion fields

Primary torsion fields represent a special kind of substance. Such fields arise as the first ones from "Absolute Nothing", transferring the information without carrying energy, with the

⁹For some experiments the static generators of torsion field are used .

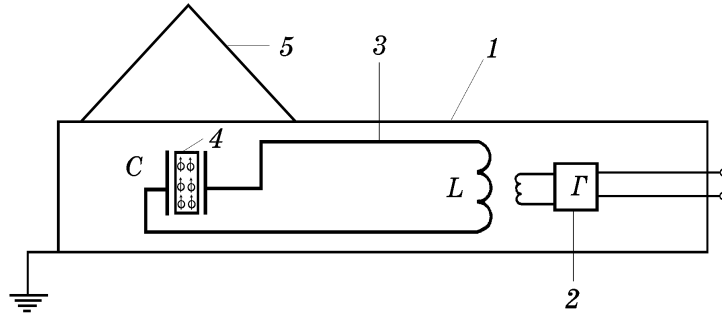

Figure 6: The principal scheme of Akimov generator. *1* – grounded all-metal body; *2* – generator of electromagnetic oscillations; *3* – output contour; *4* – ferromagnetic; *5* – cone forming the directional diagram of torsion field

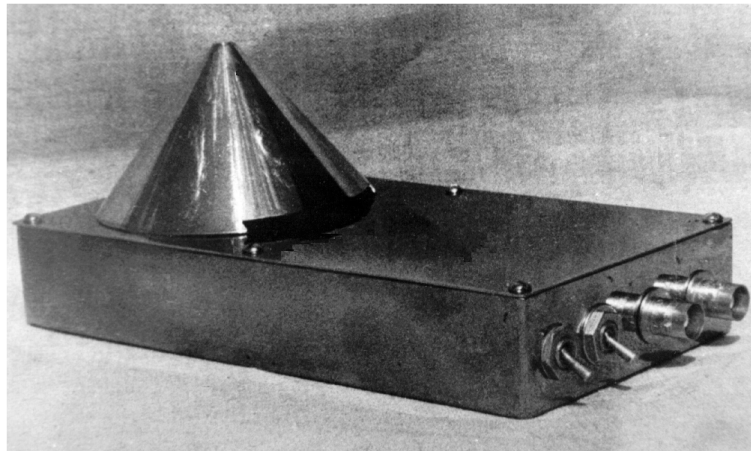

Figure 7: Exterior of Akimov generator with main functionalities and broad directional diagram. The generator allows the generation of static torsion field and torsion radiation on frequencies up to 100 MGz in modes S_R and R_L

Riemannian curvature of space being equal to zero, and the torsion being distinct from zero. Under these conditions the energy-momentum tensor of substance (15) appears to be equal to zero in all areas of space. As the outcome we obtain zero value of energy and momentum for primary torsion field.

Assuming in equations of vacuum the Riemann tensor R^i_{ijk} equal to zero, we get the equations of primary torsion fields of the following form

$$\nabla_{[k}T^i_{|j|m]} + T^i_{s[k}T^s_{|j|m]} = 0. \quad (47)$$

The field T^i_{jk} carries information, since the trial particle trajectory in primary torsion field will vary under an operation of the field according to the equations of motion (17) and (18). It is important to note, that in this situation the interaction energy and momentum of the field are equal to zero.

For research of their quantum behavior it is convenient to use non-linear spinor equations ($\overset{+}{A}^{s+}.1$) and ($\overset{+}{A}^{s+}.2$). Torsion field does not enters in these equations as a wave function, but its spinor potentials does submitted through twocomponent spinors o^α and i^α , ($\alpha = 0, 1$), , which are actually spinor representation of rotational coordinates [2]. In the case of purely torsion solution containing only one torsion parameter r_s the equations ($\overset{+}{A}^{s+}.1$) and ($\overset{+}{A}^{s+}.2$) gets the form

$$\nabla_{\beta\dot{\chi}}o_\alpha = \gamma o_\alpha o_\beta \bar{o}_{\dot{\chi}} - \alpha o_\alpha o_\beta \bar{l}_{\dot{\chi}} - \beta o_\alpha l_\beta \bar{o}_{\dot{\chi}} - \tau l_\alpha o_\beta \bar{o}_{\dot{\chi}} + \rho l_\alpha o_\beta \bar{l}_{\dot{\chi}}, \quad (48)$$

$$\nabla_{\beta\dot{\chi}}l_\alpha = \pi o_\alpha l_\beta \bar{l}_{\dot{\chi}} - \mu o_\alpha l_\beta \bar{o}_{\dot{\chi}} - \gamma l_\alpha o_\beta \bar{o}_{\dot{\chi}} + \alpha l_\alpha o_\beta \bar{l}_{\dot{\chi}} + \beta l_\alpha l_\beta \bar{o}_{\dot{\chi}}, \quad (49)$$

where the spinor components of torsion field are determined as:

$$\begin{aligned} \rho &= -(r - ir_s \cos \theta)^{-1}, \quad \beta = -\text{ctg } \theta \bar{\rho} / (2)^{3/2}, \\ \pi &= ir_s \sin \theta \rho^2 / (2)^{1/2}, \quad \alpha = \pi - \bar{\beta}, \quad \mu = Y \rho^2 \bar{\rho}, \\ \gamma &= \mu + r \rho \bar{\rho} / 2, \quad \tau = ir_s \sin \theta \rho \bar{\rho} / (2)^{1/2}, \quad Y = (r^2 + r_s^2) / 2. \end{aligned}$$

In these equations the torsion parameter r_s can not any more have the sense of Compton wavelength, since primary torsion field has no rest and motion masses.

The record of neutrino field equation (38) through twocomponent spinors(in cartesian coordinate system) has the form

$$\partial_{\beta\dot{\chi}}o_\alpha = 0, \quad \partial_{\beta\dot{\chi}}l_\alpha = 0.$$

These equations are too simple, since they do not contain any physical parameters. Therefore, most likely, the true neutrino equations are the equations (48) and (49), containing "rotary information" through torsion parameter r_s . In such interpretation neutrino should not transfer energy, that again raises the problem of energy conservation in the processes of the type (32).

The problem of energy conservation can be removed if to use for the description of neutron decay process the potential energy (33). This energy vanishes at $e = 0$ and $M = 0$, though $r_s \neq 0$, that indicates high penetrating ability of neutrino. Besides the existence of torsion hole provides "torsion defect of masses", which account restores energy conservation law.

5.4 Basic properties of torsion radiations

When we speak about torsion radiations, we imply it to be free wave fields formed, generally speaking, by sources characterized by the constant r_s in potential energy (25). This potential energy vanishes, when all physical included in it parameters, except for r_s , are equal to zero. From here follows, that:

torsion radiation has high penetrating ability.

Torsion radiation are divided on primary and secondary, with primary torsion field always being radiations. As it was shown above, energy and momentum of primary torsion field (at least their real parts) are equal to zero. Therefore it is meaningless to speak about propagation speed of primary torsion field, since:

primary torsion field, if it exists, exists at once everywhere and always.

Secondary torsion radiation has, most likely, imaginary energy and distinct from zero momentum, i.e. it is tachyon. This conclusion follows from the analysis of the solution (25). In this solution the source function (27) represent complex quantity, which imaginary part is interpreted as imaginary mass or charge. The very characteristics tachyons have. From (27) it is visible, that tachyons properties of substance are connected to parameter r_N . . However it is known, that the parameters r_N . and r_s have the same nature in the sense that the solution, containing them, can be obtained from coulomb - newtonian solution by shift along radial coordinate

$$\rho = -(r + ir_N - ir_s \cos \theta)^{-1}$$

in complex region¹⁰. Hence:

secondary torsion radiation is tachyon and has superlight velocity of propagation .

The possibility of superlight signals registration was considered in the scientific literature (see, for example, [34]), and three independent groups have informed about their astronomical observation [35, 36, 37].

References

- [1] *Rarita W., Schwinger J.* // Phys. Rev. 1941. Vol. 59. P. 436.
- [2] *Shipov G.I.* The theory of physical vacuum. M.: Nauka, 1997, p.450.
- [3] *Einstein A.* // Coll. papers. M.: Nauka, 1966. V.2, c.63.
- [4] *Shipov G.I.* // Izv. vuzov. Fizika. 1972, N 10, pp.98-104.
- [5] *Rutherford E.* // Philos. Mag. 1919. Vol. 37. P.537.
- [6] *Kinzingler E.* // Ztschr. Naturforsch. A. 1949. Bd.4. S.88.
- [7] *Hofstadter R.* // Rev. Mod. Phys. 1956. Vol. 28, N 3. P.814.

¹⁰Thus, using Coulomb potential it is possible to enter Dirac monopole.

- [8] *Goubarev E., Sidorov A., Shipov G.* // Proceedings of the fifth seminar "Gravitational energy and gravitational waves". Doubna, 1993, p.232.
- [9] *Shipov G.I.* // Proceedings of the sixth seminar "Gravitational energy and gravitational waves". Doubna, 1994, p.141.
- [10] *Shipov G.I.* // Izv. vuzov. Fizika.1977.N6.P.142.
- [11] *Pice A.* Scientific Activity and Life of Albert Einstein. M.: Nauka, 1989, 280 p.
- [12] *Shipov G.I.* // Proceedings of 7th Russian Conference "Modern theoretical and experimental problems of relativity theory and gravitation". Erevan, 1988, pp.233-235.
- [13] *Shipov G.I.* The program of universal relativity and vacuum theory. M., 1988. Dep. v VINITI, N6947-V88.
- [14] *Newman E., Penrose R.* // J.math.phys. 1962.V.3.N3.PP.566-587.
- [15] *Terleckiy Ya.P.* // Proceedings of 7th Russian Conference "Modern theoretical and experimental problems of relativity theory and gravitation". Erevan, 1988, pp. 457.
- [16] *Machwe M.K., Kent P.W., Snowdon S.C.* //Phys.Rev. 1959. V.114, N6, p.1563.
- [17] *Goubarev E., Sidorov A., Shipov G.* Fundamental models of elementary interactions and the theory of vacuum. M.: CISE VENT, 1992, 68 p.
- [18] *Goubarev E., Sidorov A.* // Proceedings of 28th conference dep. of physical, mathematical and natural sciences of UDN. M.,1992, Suppl., p.3.
- [19] *Goubarev E., Sidorov A.* // Proceedings of 8th Russian conference "Theoretical and experimental problems of gravitation". M., Russ. gravit. assoc., 1993, p.251.
- [20] *Valentan L.* Subatomic physics: nuclei and particles. In 2 vol., M.: Mir,1986.
- [21] *Crish A.D.* // V mire nauki. 1987, N10, p.12.
- [22] *Mott N.* //Proc.Roy.Soc. London. A. 1929.Vol.124, p.425.
- [23] *Fedyanin V.* Electromagnetic structure of nuclei and nuclons. M.: Visch. shk., 1968.
- [24] *Akimov A.E.* Heuristic discussion of search for new long-range actions. The EGS-concepts. M.: CISE VENT, 1991, 63 p.
- [25] *Akimov A.E., Kourik M.V., Tarasenko V.Ya.* // Biotehnologiya.1991, N3, p.69.
- [26] *Pagot J.* Radiesthesie et emission de forme. P.: Malonie, 1978. 277 p.
- [27] *Winter D.* // The Seed and the EGG. A Galacti context. Cristall hill farm. Eden, N.Y., 1988, p.219.
- [28] *Schwinger P.* Pat. P3320518.3. (Bundesrepublik Deutschland). Publ. 13.12.84.
- [29] *Fantuzzi G.* Pat. 250943.9.(Bundesrepublik Deutschland). Publ. 18.09.75.

- [30] *Goulak Yu.K.* // *Izv. vuzov. Fizika.* 1971, N10, p.46,52; 1973, N4, p.51.
- [31] *Chechelnicliy A.M.* Extremity, stability, resonance in astrodynamics and spacecraft. M.: Mashinostroeniye, 1980.
- [32] *Shipov G.I.* Theoretical estimation of electrotorsion radiation. M.: Preprint N1. MITPF, 1995, 21 p.
- [33] *Frolov V.* // *Proc. of FIAN*, 1977, v.96, pp.72-180.
- [34] *Terleckiy Ya.P.* Paradoxes of relativity theory. M.: Nauka, 1966.
- [35] *Kozyrev N.A.* Space observations through physical properties of time. Blazing up stars. Erevan: ArmANSSR Izdat.1977, p.168-179.
- [36] *Lavrentyev M.M., Eganova I.A., Lucet M.K. et al* // *Dokl. AN SSSR.* 1990, v.314, N2, pp.352-354.
- [37] *Akimov A.E., Pougach A.F.* On the question of possibility of discovering of torsion waves by astronomic methods. M., 1992, 19 p., Preprint CISE VENT, N17.